

Please order by parts number, not key number
 Veuillez indiquer le numéro de la pièce (Non "Key" No.)

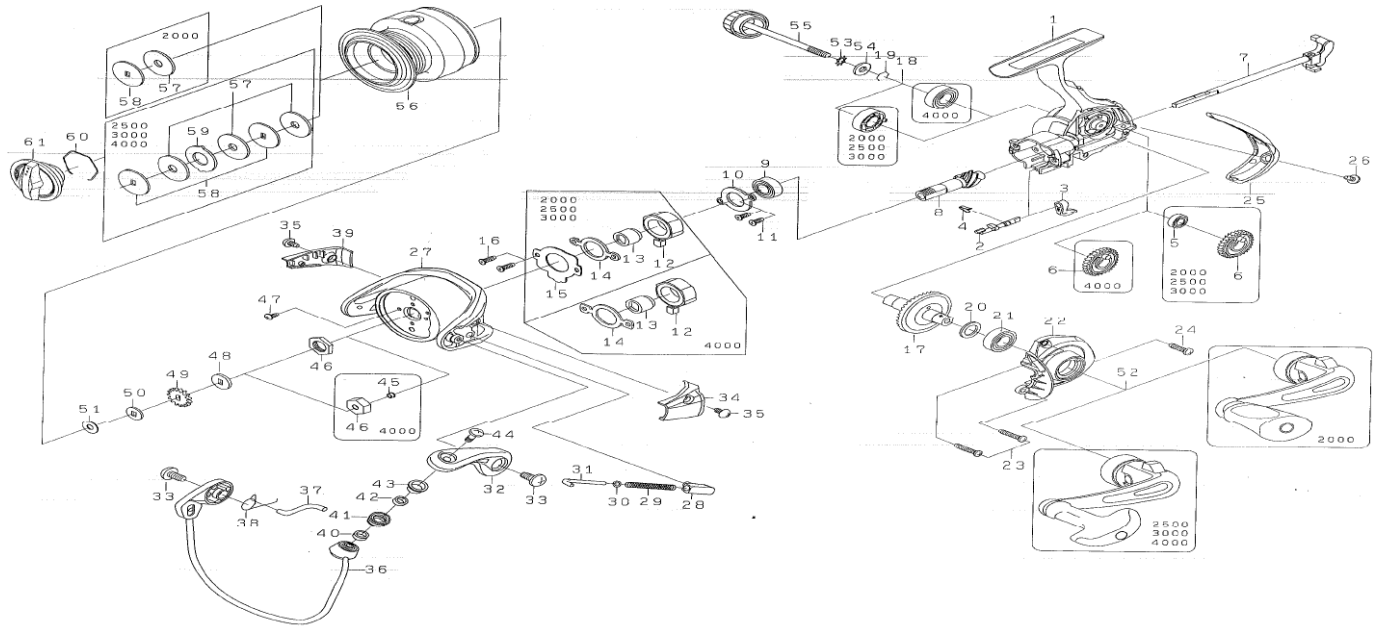

SPINNING REEL CF2000-3Bi/2500-3Bi/3000-3Bi/4000-3Bi



CROSSFIRE 2000-3BI			CROSSFIRE 2500-3BI	CROSSFIRE 3000-3BI	CROSSFIRE 4000-3BI
Key No.	Parts No.	Parts Name	Key No.	Key No.	Key No.
1	Q07-4402	BODY	Q06-8703	Q06-8703	Q07-1503
2	H46-3101	ANTI-REVERSE CAM	H46-3101	H46-3101	H50-8301
3	H46-3203	ANTI-REVERSE LEVER	H46-3203	H46-3203	H46-3203
4	Q07-3601	ANTI-REVERSE CAM SPRING	Q07-3601	Q07-3601	Q07-3601
5	G90-8001	BALL BEARING (A)	G90-8001	G90-8001	---
6	Q07-4801	OSCILLATING GEAR	G90-8101	G90-8101	G98-6301
7	Q07-4601	MAIN SHAFT	Q06-8801	Q06-8801	Q09-6901
8	Q08-4801	PINION GEAR	Q08-5001	Q08-5001	Q08-5102
9	H72-6801	BALL BEARING (B)	H72-6801	H72-6801	H73-5001
10	H46-3901	BEARING RETAINER (A)	H46-3901	H46-3901	H50-9101
11	H62-4901	SCREW (A)	H62-4901	H62-4901	H62-4901
12	Q06-9001	ROLLER CLUTCH	Q06-9001	Q06-9001	G84-5601
13	H62-4702	SPACING SLEEVE	H62-4702	H62-4702	G74-3003
14	Q09-9001	CLUTCH CAM RETAINER	Q09-9001	Q09-9001	Q09-7601
15	H46-4001	ROLLER CLUTCH RETAINER	H46-4001	H46-4001	---
16	G83-7101	SCREW (B)	G83-7101	G83-7101	G83-7101
17	Q08-4901	DRIVER GEAR	G90-8602	G90-8602	G92-4302
18	G88-9301	BEARING	G88-9301	G88-9301	H11-0101
19	G52-5101	BEARING RETAINER (B)	G52-5101	G52-5101	G52-5101
20	373-7800	WASHER (A)	373-7800	373-7800	373-7800
21	H11-0101	BALL BEARING (D)	H11-0101	H11-0101	H11-0101
22	Q07-5102	SIDE COVER	Q06-9403	Q06-9403	Q07-1903
23	G11-5001	SCREW (C)	G11-5001	G11-5001	G11-5001
24	H62-4901	SCREW (D)	H62-4901	H62-4901	G83-7101
25	Q07-5201	REAR COVER	Q06-9601	Q06-9601	Q07-2001
26	G27-0801	SCREW (E)	G27-0801	G27-0801	G27-0801
27	H49-4807	ROTOR	H86-2703	H86-2703	H86-2903
28	H49-6701	BAIL SPRING HOLDER	H49-6701	H49-6701	H50-9701
29	G47-1701	BAIL SPRING	G47-1701	G47-1701	G64-6201
30	E31-3901	WASHER (B)	E31-3901	E31-3901	E31-3901
31	G47-1805	BAIL SPRING SHAFT	G47-1805	G47-1805	G29-8201
32	H46-4503	BAIL ARM	H46-4503	H46-4503	H46-4503
33	G20-5001	SCREW (F)	G20-5001	G20-5001	G20-5001
34	H49-6802	COVER(A)	H49-6802	H49-6802	H50-9802
35	G27-0801	SCREW (G)	G27-0801	G27-0801	G27-0801
36	H87-0201	BAIL ASSEMBLY	Q07-2501	Q07-2501	Q07-4001
37	G63-0801	BAIL TRIP LEVER	G61-3001	G61-3001	G64-6501
38	G61-3101	BAIL TRIP LEVER SPRING	G61-3101	G61-3101	G61-3101
39	H49-8002	COVER(B)	H49-6902	H49-6902	H51-0102
40	G87-4201	COLLAR (A)	G87-4201	G87-4201	G87-4201
41	F62-5005	LINE ROLLER	F62-5005	F62-5005	F62-5005
42	G87-4301	COLLAR (B)	G87-4301	G87-4301	G87-4301
43	G15-2503	COLLAR (C)	G15-2503	G15-2503	G15-2503
44	G19-5602	SCREW (H)	G19-5602	G19-5602	G19-5602
45	---	COLLAR (D)	---	---	---
46	H71-1901	ROTOR NUT	H71-1901	H71-1901	Q08-6801
47	G62-7701	SCREW (I)	G62-7701	G62-7701	G62-7701
48	H11-8501	WASHER (C)	H11-8501	H11-8501	H11-8501
49	G83-9301	CLICK GEAR	G83-9301	G83-9301	G83-9301
50	E46-7101	WASHER (D)	E46-7101	E46-7101	E46-7101
51	E39-8002	WASHER (E)	E39-8002	E39-8002	E39-8002
52	Q08-5201	HANDLE ASSEMBLY	Q07-7601	Q07-7601	Q07-9901
53	160-8101	WASHER (F)	160-8101	160-8101	160-8101
54	G86-3901	WASHER (G)	G86-3901	G86-3901	G86-3901
55	Q02-0102	HANDLE SCREW	Q02-0102	Q02-0102	Q02-0202
56-60	Q08-5301	SPOOL ASSEMBLY	Q07-7901	Q07-7901	Q08-0001
57	E13-6001	WASHER (H)	E13-6001	E13-6001	E13-6001
58	E46-7201	WASHER (I)	E46-7201	E46-7201	E46-7201
59	---	WASHER (K)	373-3606	373-3606	373-3606
60	F37-3301	DRAG WASHER RETAINER	F37-3301	F37-3301	F37-3301
61	G84-0501	DRAG KNOB	G84-0501	G84-0501	G84-0501